

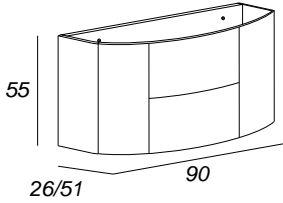
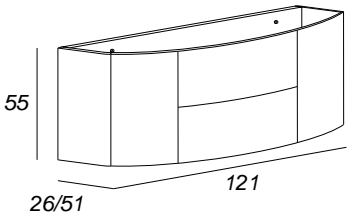
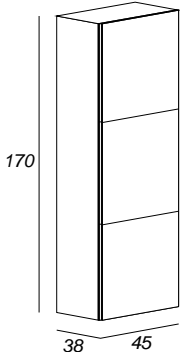
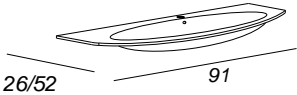
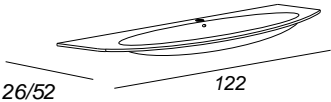

Scheda Tecnica Modo IPER CERAMICA		<i>Colori - Colors - Farben - Couleurs</i>				
		<i>it</i> <i>gb</i> <i>de</i> <i>fr</i>	Grigio talpa op. Mole gray Talpagrau Gris taupe	Rovere sc. Soft Dark oak soft Eiche soft Chêne foncé soft	Grigio natura Nature gray Natur grau Gris nature	Frassino bianco White ash Esche weiss Frêne blanc
		Art. 55069 Ref: 22007	Art. 55070 Ref: 22008	Art. 55071 Ref: 22009	Art. 55072 Ref: 22010	Art. 55073 Ref: 22011
		Mobile MDF spess. lat. mm 25 / front. mm 19 Interno: Grigio Piedini: NO Ante: n°2 Laterali - Push/soft Cassetti: n°2 Centrali - Push/Soft - sponda metallo Ripiano: n° 1 Centrale Fisso nei vani laterali Maniglia: NO				
		Art. 54407 Ref: 16155	Art. 54408 Ref: 16156	Art. 54417 Ref: 16157	Art. 54418 Ref: 16158	Art. 54842 Ref: 22012
		Mobile MDF spess. lat. mm 25 / front. mm 19 Interno: Grigio Piedini: NO Ante: n°2 Laterali - Push/soft Cassetti: n°2 Centrali - Push/Soft - sponda metallo Ripiano: n°1 Centrale Fisso nei vano laterali Maniglia: NO				
 <small>Reversibile</small>		Art. 53131 Ref: 16145	Art. 53132 Ref: 16146	Art. 53126 Ref: 16147	Art. 53117 Ref: 16148	Art. 44845 Ref: 22013
		Colonna in MDF sp.16 mm finit. PVC Interno: Grigio Ante: n°3 con chiusura Soft-Close Maniglia: Fresatura su anta Ripiano: n°2 Centrali fissi + n°1 in vetro per ogni vano NOTE: KIT porta accessori per vano centrale compreso				
 		VETRO Art. 82399 Ref: 16159	Lavabo in vetro, spessore 15 mm resistente alle alte temperature. Misure int. vasca: cm 61x33xh12			
		Art. 82368 Ref: 16160	Lavabo in vetro, spessore 15 mm resistente alle alte temperature. Misure int. vasca: cm 93x33xh12			
 		RESINA Art. 50177 Ref: 16163	Lavabo in resina super resistente agli urti. Misure int. vasca: cm 61x33xh11,5			
		Art. 50178 Ref: 16164	Lavabo in resina super resistente agli urti. Misure int. vasca: cm 93x33xh11,5			

Scheda Tecnica Modo

IPER CERAMICA

Vista laterale interna

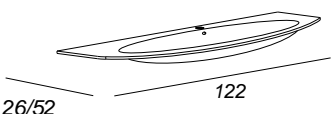
Vista posteriore

Istruzioni per allacci idraulici

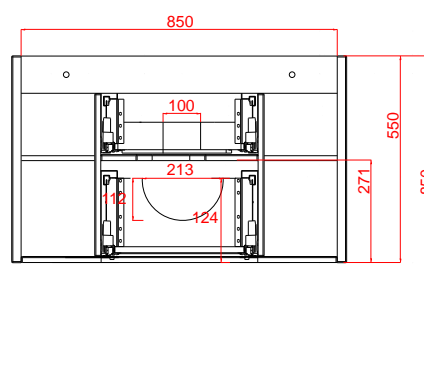
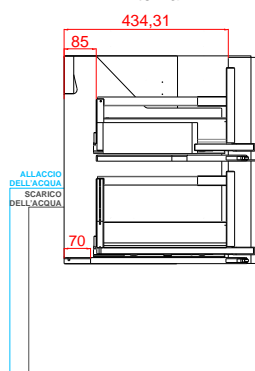
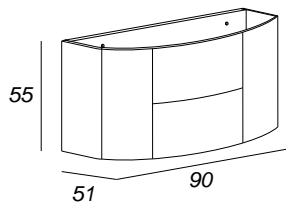

ATTENZIONE:
Si consiglia di installare il mobile sospeso ad una altezza da terra di 85cm.
Se lo si volesse installare ad un'altezza differente, consigliamo di tenere sempre come riferimento l'altezza del fianco del mobile.

MISURE INDICATIVE

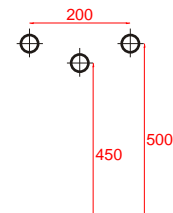

Vista laterale interna

Vista posteriore

Istruzioni per allacci idraulici

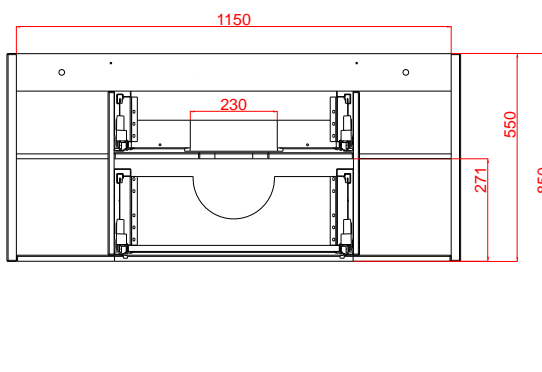
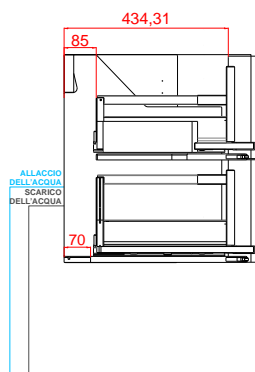
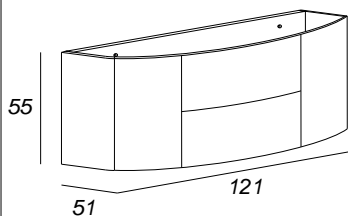

MISURE INDICATIVE

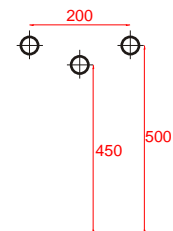

Vista superiore

Vista in sezione

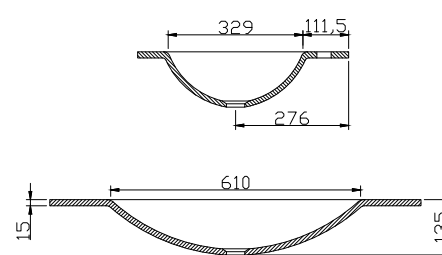
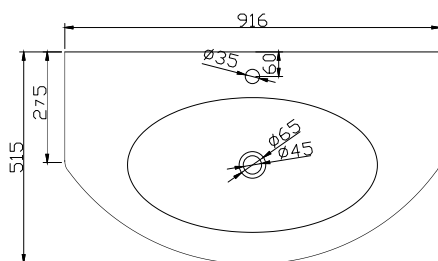
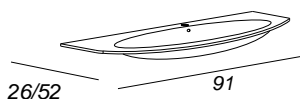

MISURE INDICATIVE

Vista superiore

Vista in sezione

