

Scheda Tecnica  
Minoa

it  
gb  
de  
fr

Bianco lucido  
White glossy  
Weiss hochglanz  
Blanc brillant

Rovere scuro soft  
Dark oak soft  
Eiche soft  
Chêne foncé soft

**IPER CERAMICA**

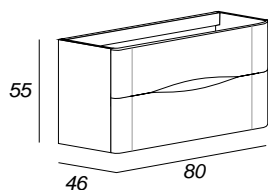

Art.  
55065  
**Ref: 22003**

Art.  
55066  
**Ref: 22004**

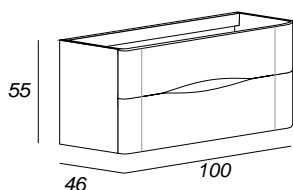

Art.  
55067  
**Ref: 22005**

Art.  
55068  
**Ref: 22006**

Mob. MDF spess. lat. mm 16/ front. mm 19  
Interno: Tessuto  
Cassetti: n°2 MDF / chiusura Soft-Close,  
sponda metallo  
Ripiano: NO  
Maniglia: Fresata su Frontale  
Frontale con laterali arrotondati

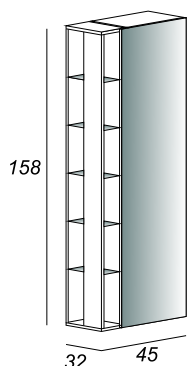

Art.  
53171  
**Ref: 16132**

Art.  
53172  
**Ref: 16238**

Colonna in MDF sp.16 mm  
Interno: Tessuto  
Cassetti: NO  
Ante: n°1 con specchio fumè Soft-Close  
Ripiani interni: n°2 fissi + 2 vetro mobili  
Ripiani a giorno: n°8 in vetro  
Maniglia: NO



Reversibile

**Finitura Opaca**

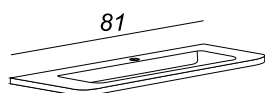

46

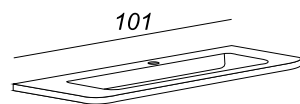

46



Rigenerabile  
Regenerable  
Regenerierbar  
Régénérable

Art.  
50220  
**Ref: 21147**

Art.  
50221  
**Ref: 21148**

Lav. resina OPACO super resistente agli urti.

Misure int. vasca: cm 55x28xh12

Lav. resina OPACO super resistente agli urti.

Misure int. vasca: cm 65x28xh12

# Scheda Tecnica

## Minoa

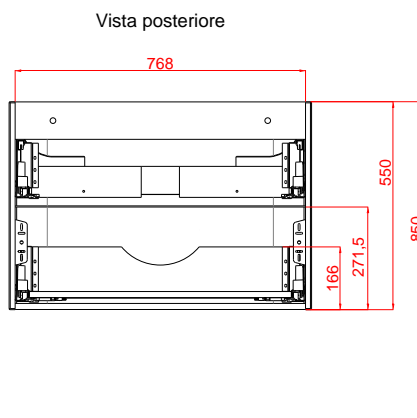
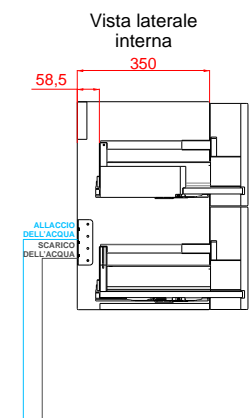
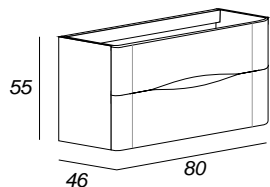

Istruzioni per allacci idraulici

**ATTENZIONE:**  
 Si consiglia di installare il mobile sospeso ad una altezza da terra di 85cm.  
 Se lo si volesse installare ad un'altezza differente, consigliamo di tenere sempre come riferimento l'altezza del fianco del mobile.

**MISURE INDICATIVE**

ALLACCIO ACQUA    ALLACCIO ACQUA



SCARICO DELL'ACQUA

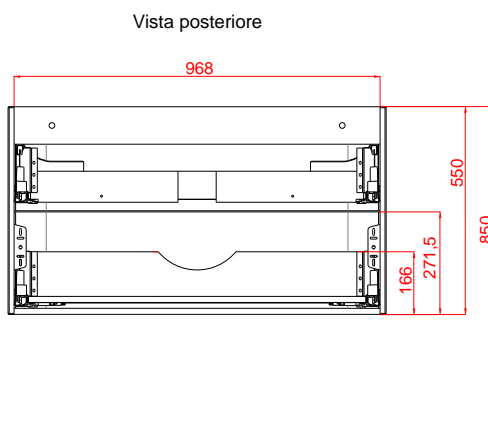
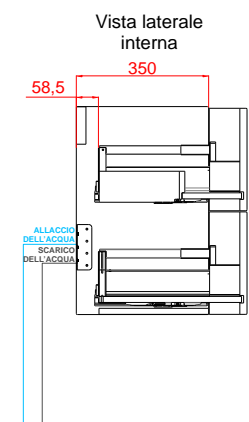
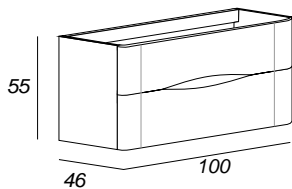

Istruzioni per allacci idraulici

**ATTENZIONE:**  
 Si consiglia di installare il mobile sospeso ad una altezza da terra di 85cm.  
 Se lo si volesse installare ad un'altezza differente, consigliamo di tenere sempre come riferimento l'altezza del fianco del mobile.

**MISURE INDICATIVE**

ALLACCIO ACQUA    ALLACCIO ACQUA



SCARICO DELL'ACQUA

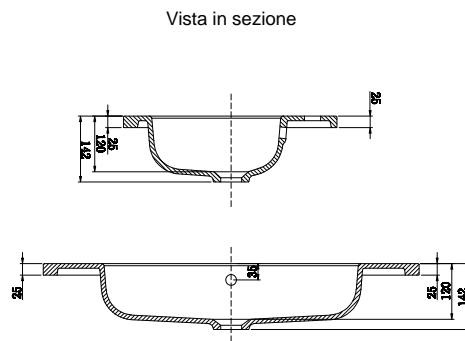
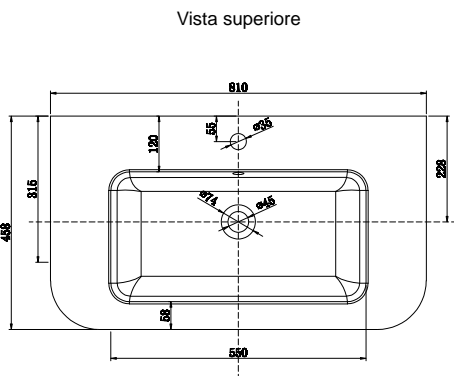
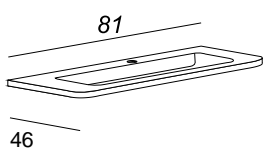

**MISURE INDICATIVE**

