

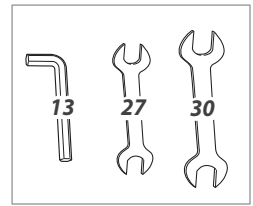

IT

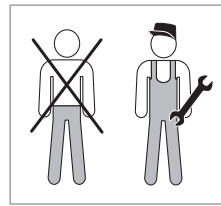

Serie Esedra - Valvole manuali - Simple regulation radiator valves

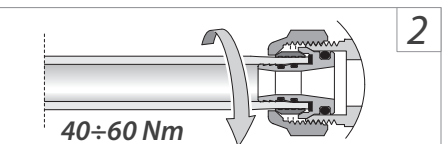
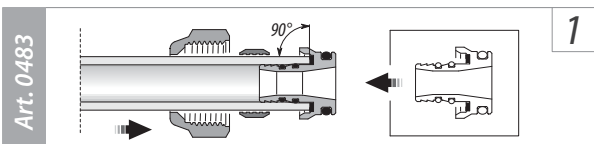
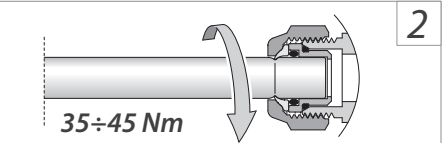
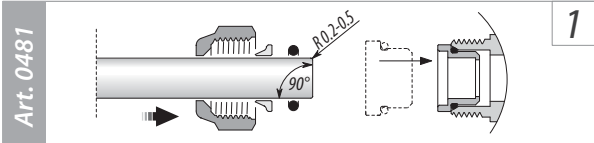
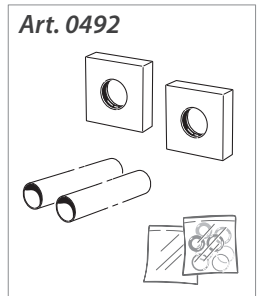
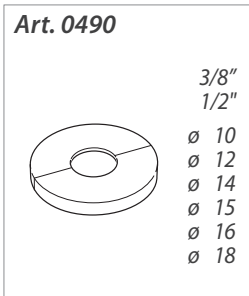
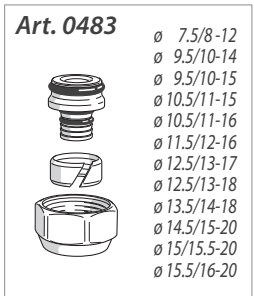
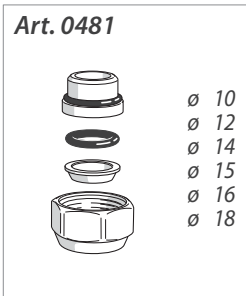
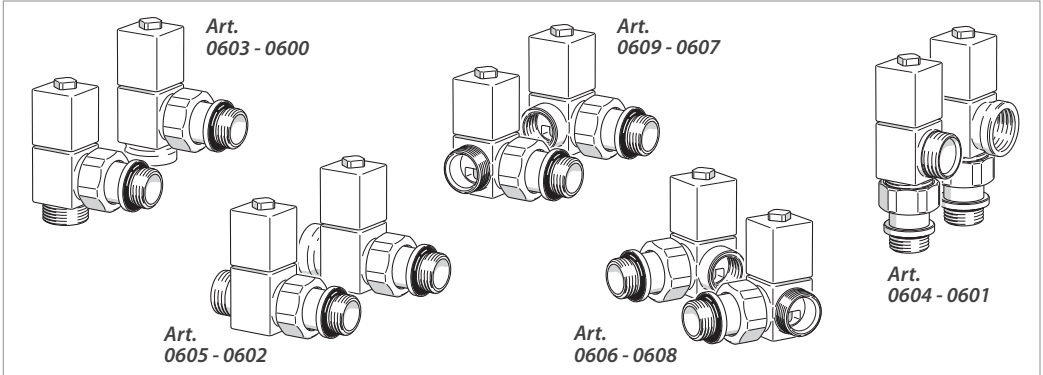



2 - 130°C (36-266°F)
Max 10 bar (145 psi)



Canapa - PTFE (Teflon)
Hemp - PTFE (Teflon)

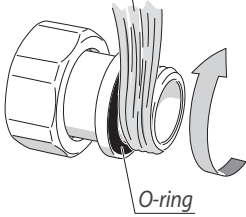

1

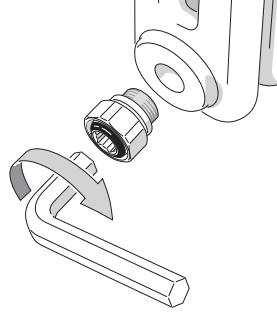

2

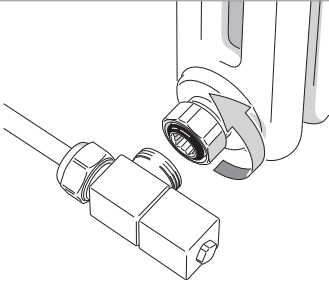

3

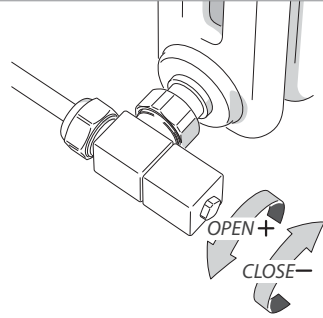

4

2

Art. 0600-0603-0601-0604

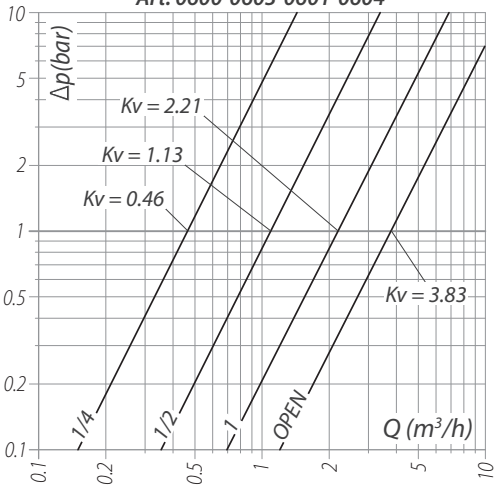

Art. 0602-0605-0606-0608-0607-0609

